



RECAMBIO PISONES Y CONSTRUCCIÓN RAMMER AND CONSTRUCTION PARTS

ÍNDICE DE CONTENIDOS

PÁG

PISÓN - RECAMBIO MOTOR HONDA RAMMER ENGINE PARTS - HONDA	518-519
PISÓN - RECAMBIO MOTOR WACKER RAMMER ENGINE PARTS - WACKER	520-521
PISÓN - RECAMBIO MOTOR WEBER- MIKASA RAMMER ENGINE PARTS - WEBER-MIKASA	521



RECAMBIOS PARA PISÓN HONDA

HONDA	29-005
GX-100 GXR-120	
Ref. Orig. 30500Z0D013	

HONDA	29-014
GX-100 GXR-120	
Ref. Orig. 31110Z0D003	

HONDA	01-201
GX-100 GXR-120	
Ref. Orig. 36100ZE1015	

HONDA	01-056
GX-100 GXR-120	
Ref. Orig. 28400Z0DV02ZC	

HONDA	01-603
GX-100 GXR-120	
Ref. Orig. 28442ZE6003	

HONDA	16100-ZDJ-813
PARA PISONES GXR-120 PISÓN	
Ref. Orig. 16100ZDJ813	

HONDA	01-128
GX-100	
Ref. Orig. 16100Z0D003	

HONDA	03-301
GX-100	
Ref. Orig. D10HD	

HONDA	02-330
PISÓN MIKASA GX-100	
Ref. Orig. 366010080	

HONDA	23-168
MTX-70, MTX-80 MTX-90, GX-100 PISON MIKASA	
Ref. Orig. 366010070 366345980	

HONDA	02-324
133 x 114 x 20 MM	
GX-100 GXR-120	
Ref. Orig. 17211ZL8000/023	

HONDA	23-301
FILTRO AIRE Y TUBO ESCAPE COMPLETO	
PISON, GX-120 GX-160, GX-200	

HONDA	21-404
GX-120 GX-160 PISÓN	
158 X 45 X 19 MM	
Ref. Orig. 17210ZJ7V01	

HONDA	21-405
PREFILTRO AIRE PARA 21-404	
GX-120 GX-160 PISÓN	
Ref. Orig. 17218ZK7V01	

HONDA	29-004
GX-100 GXR-120	
Ref. Orig. 17221Z0D000	

RECAMBIOS PARA PISÓN HONDA



HONDA	29-003
GX-100 GXR-120	
	
Ref. Orig. 17231Z0D000	

HONDA	23-303
GX-100 GXR-120	
L- 80 MM	
	
Ref. Orig. 16561Z0D000	

HONDA	23-304
GX-100 GXR-120	
L- 40 MM	
	
Ref. Orig. 16562Z0D000	

HONDA	03-1250
VÁLVULA ESCAPE Y ADMISIÓN	
	
Ref. Orig. 17211ZL8000/023	

HONDA	01-594
DIAM. 56 MM	
GX-100	
	
Ref. Orig. 13101Z0D000	

HONDA	01-401
DIAM. 56 MM	
GX-100	
	
Ref. Orig. 13010Z0D003	

HONDA	01-426
GX-100	
	
Ref. Orig. 13200Z0D000	

HONDA	29-006
GX-100 GXR-120	
	
Ref. Orig. 18310ZM0000	

HONDA	29-011
GX-100 GXR-120	
	
Ref. Orig. 18321ZL8000	

HONDA	01-452
GX-100	
	
Ref. Orig. 90745ZE1600	

HONDA	29-007
GX-100	
	
Ref. Orig. 14400Z0D003	

HONDA	29-010
GX-100	
	
Ref. Orig. 19610Z0D000Z	

HONDA	29-008
GX-100 GXR-120	
	
Ref. Orig. 016A1ZH7010 16010ZH7003	

HONDA	02-031
GX-100 GXR-120	
	
Ref. Orig. 17620ZL8003 15650ZM0003	

HONDA	29-009
GX-100	
	
Ref. Orig. 22000Z0Z003	

HONDA	23-300
GX-120 GX-160	
EJE 19,05 MM DIAM EXT. 79 MM	
	



RECAMBIOS PARA PISÓN WACKER

WACKER	01-568
BS-60	
Ref. Orig. 157193	

WACKER	02-424
BS50-2I, BS60-2I BS70-2I, BS60-4S	
Ref. Orig. 5200003062	

WACKER	02-377
BS500, 600 BS700	
Ref. Orig. 95254 95294 6114792	

WACKER	02-378
BH-22, 23, 24, 55, 65 BS-23	
Ref. Orig. 95711	

WACKER	01-641
WM80, BS500 BS502, BS502I BS600, BS602 BS602I, BS700 BS702	
Ref. Orig. 0103302 0049598	

WACKER	02-282
BS45Y, BS52Y BS65Y, BS600 BS650, BS700 BH22, BH23 BH24	
Ref. Orig. 81072	

WACKER	02-283
BS500 BS600 BS650 BS700	
FILTRO GASOLINA	
Ref. Orig. 155079	

WACKER	01-563
BS-60 BS-500 / 502 BS-600 / 602 BS-700 / 702	
WM-80	
Ref. Orig. 46098	

WACKER	03-771
BS-60 BS-500 / 502 BS-600 / 602 BS-700 / 702	
WM-80	

WACKER	01-566
BS-60-2 BS-500 BS-700	
WM-80	
Ref. Orig. 86430	

WACKER	22-898
CAMPANA EMBRAGUE PARA MOTOR 2 TIEMPOS	
WM-80, BS-50 BS-60, BS-65 BS-70, BS-500 BS-600, BS-650 BS-700	
Ref. Orig. 110232	NEW

WACKER	28-899
CAMPANA EMBRAGUE PARA MOTOR 4 TIEMPOS	
BS-600-4 GX-100 EH-12	
	NEW

WACKER	01-565
BS-60 WM-80 BH-23	
DIAM. 45 MM	
Ref. Orig. 0099336	

WACKER	22-600
45 MM DESPUÉS 2011 CATALIZADOR	
Ref. Orig. 0176400	

WACKER	02-281
BS-500, 600, 650, 700 WM-80 BS-45, 52, 60, 62, 65	
Ref. Orig. 160986	

RECAMBIOS PARA PISÓN WACKER



WACKER	03-1090
BS-600, 700 WM-80, 90	
Ref. Orig. 114770	

WACKER	21-510
BS-45Y BS-52Y BS-60Y BS-62Y	
Ref. Orig. 0087456 500087456	

WACKER	21-511
BS-50-2I BS-60-2I BS-70-2I	
WALBRO HDA-242	
Ref. Orig. 5000165604 0165604	

WACKER	01-564
BS-60 BS-70	
Ref. Orig. 612954	

WACKER	03-919
BS-45, 52, 65 BS-600,650,700	

WACKER	02-279
BS-500, 600, 650, 700	
Ref. Orig. 118148	

WACKER	02-280
BS-500, 600, 650, 700	
Ref. Orig. 102274	

WACKER	22-041
BS-500 BS50-2 BS50-4	
DIAM 135 MM ALTURA 210 MM	
Ref. Orig. 0102862	

WACKER	02-278
BS60-2I, BS60-4 BS60-45, BS600, BS600S BS60Y, BS650, BS65Y BS70-2I, BS700, DS70 DS720, MIKASA74FA	
FUELLE DIAM. 170 MM ALTURA 260 MM	
Ref. Orig. 1006882	



RECAMBIOS PARA OTROS PISONES

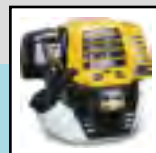

MIKASA	23-184
FUELLE MIKASA DIAM INT 160 MM ALTURA 250 MM	
MTX-70, MTX-80 MTX-90, MT-74F MT-76, MT-85H MT-86	
Ref. Orig. 354010010	



WEBER	02-278
FUELLE WEBER DIAM INT 170 MM ALTURA 260 MM	
SRV590, SRV600i SRV620, SRV660 SRV750D	
Ref. Orig. 20025316	

